

TB 中压透浦式鼓风机性能参数

# Blowers & Fans

Centrifugal Blower

## 透浦式鼓風機 CE



台灣產品新型專利第 303596 • 345887 • 305027 • 142704 • 338103 • M425944 號  
中國產品新型專利第 1643086 號

## 透浦式鼓風機 Turbo Blower (Centrifugal Blower)

at 50/60HZ

型式 Type	相數 Phase	功率 Output (KW)	電壓 Voltage (V)	電流 Current (A)	最大靜壓 (吐出) Pressure (Max.) (kpa)	最大風量 (吐出) Air Flow (Max.) (m <sup>3</sup> /min)	出口 口徑 Out Let	噪音 Noise Level (dB)	重量 Weight (Kg)
TB100-1	3~	0.75	220 380	3 1.8	1.3/2.1	18/22	100mm	70/80	22
TB100-2	3~	1.5	220 380	5.5 3.5	2/3	20/25	100mm	70/85	26
TB125-3	3~	2.2	220 380	8 5	2.4/3.6	33/39	125mm	80/90	35
TB150-5	3~	3.7	220 380	13 7.5	3.8/5.3	48/53	150mm	90/95	57
TB150-7.5	3~	5.5	220 380	19 11.5	3.8/5.3	50/65	150mm	90/95	66
TB150-10	3~	7.5	220 380	26 15.5	3.8/5.3	60/75	150mm	90/95	75
TB150L-7.5A	3~	5.5	220 380	19 11.5	5/6.5	36/48	150mm	90/100	70
TB150L-10	3~	7.5	220 380	26 15.5	5/6.5	40/53	150mm	90/100	80
TB200-15	3~	11	220 380	36 22	5/6.5	65/85	200mm	95/110	130
TB200-20	3~	15	220 380	47 28	5/7	90/100	200mm	95/110	140

### 性能表 Characteristic curves

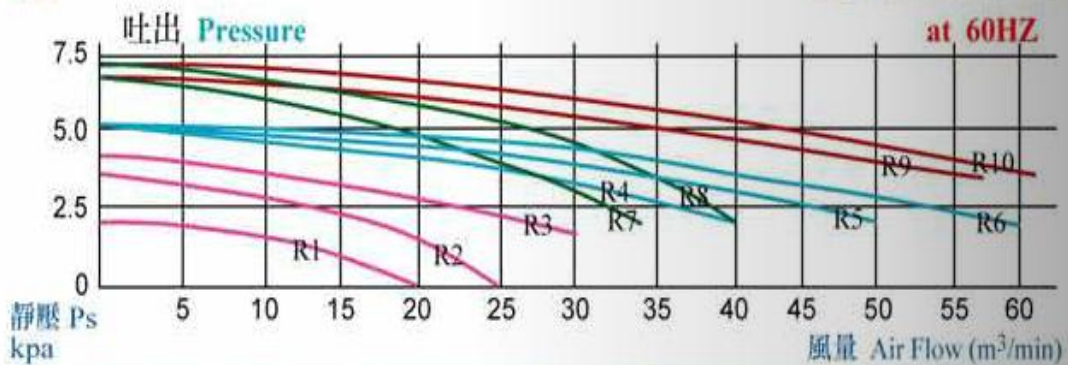
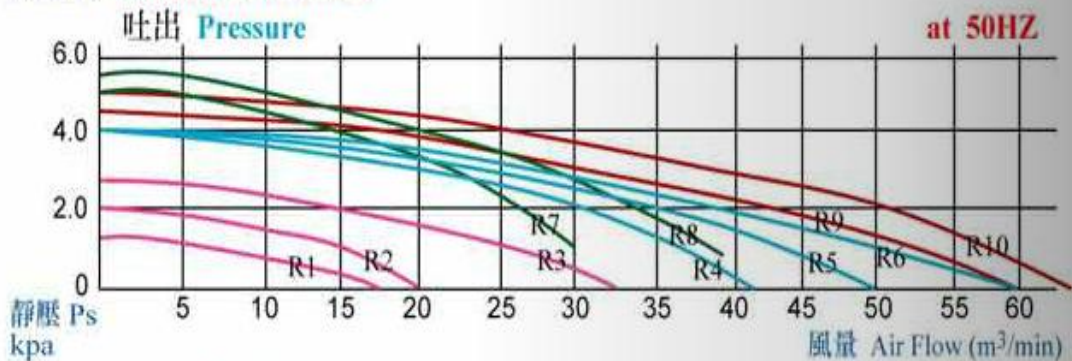

編號	品名	編號	品名	編號	品名	編號	品名
R1	TB100-1	R2	TB100-2	R3	TB125-3	R4	TB150-5
R5	TB150-7.5	R6	TB150-10	R7	TB150L-7.5A	R8	TB150L-10
R9	TB200-15	R10	TB200-20				



# 透浦式鼓風機 Turbo Blower (Centrifugal Blower)

尺寸圖 Dimension (mm)

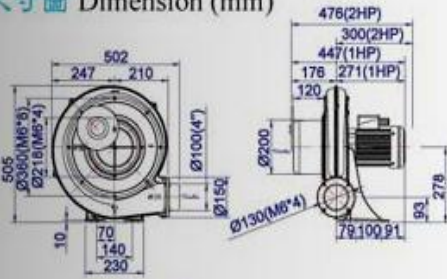

TB100-1 / TB100-2

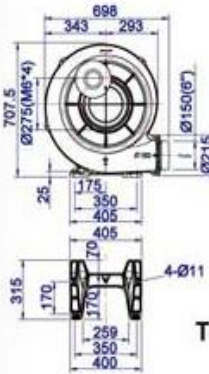

TB150-7.5 / TB150-10

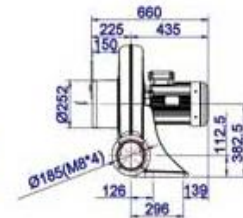

TB125-3

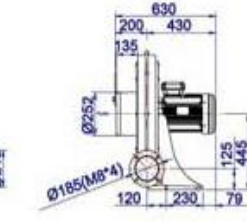
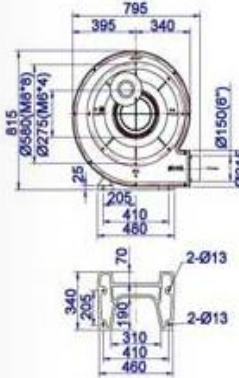

TB150L-10

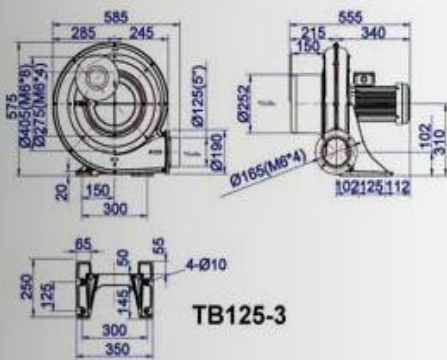

TB150-5

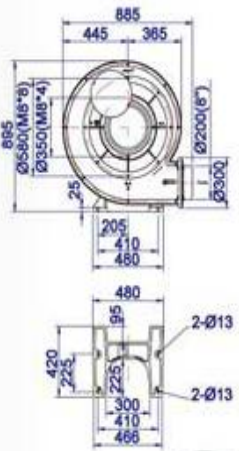

TB200-15 / TB200-20



TB200-20



TB125-3

全国直销服务热线 13661695091